



HOT GAS DEFROST MEDIUM PROFILE JUCT UNIT COOLERS

PRODUCT DATA & INSTALLATION

Medium and Low Temp Applications
(-30°F Room Temp. or Higher)
Electrical Power: Single &
Three Phase 50/60Hz

Bulletin: T30-JUCTHG-PDI-13
1068741

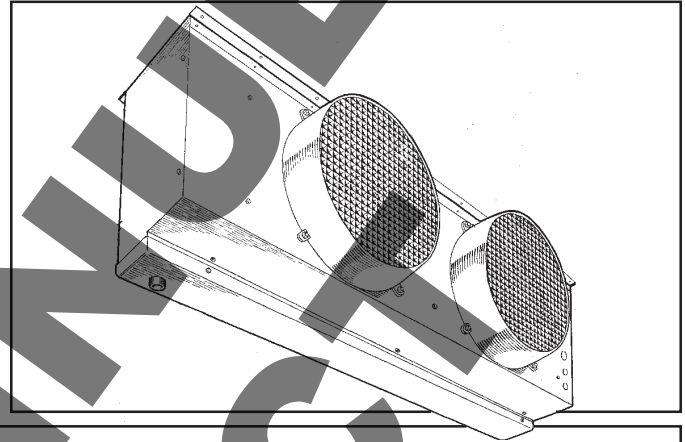

NOMENCLATURE

JUCT 1 24- H E-T3 B

MODEL _____
TRENTON MEDIUM PROFILE
UNIT COOLER

NUMBER OF FANS _____

MBH CAPACITY @ -20 °F _____
EVAP TEMP 10°F TD
24 = 24,000 BTUH

TYPE OF EVAP DEFROST _____
H=3 PIPE DEFROST
R=REVERSE CYCLE DEFROST
T=THERMO SAVER DEFROST
G=DUAL 3-PIPE / REVERSE (STOCK MODEL)

REVISION LEVEL
B=2nd GENERATION

ELECTRICAL DESIGNATION
S2 = 208-230/1/60 S6 = 200-220/1/50
T3 = 208-230/3/60 T7 = 200-220/3/50
T4 = 460/3/60 T9 = 380-400/3/50
T5 = 575/3/60

TYPE OF DRAIN PAN DEFROST
E=ELECTRIC (STANDARD)
G=HOT GAS LOOP

- Heavy gauge textured aluminum cabinet construction resists scratches/corrosion and minimizes weight for shipment, installation and service.
- Attractive and durable high density polyethylene fan guards with built-in throw boosters.
- 3/8 Tubing coil construction (reduces operating charge).
- Available for reverse cycle or 3-pipe hot gas defrost systems.
- Adjustable Defrost Termination Thermostat with dual Fan Delay function.
- Standard models include electric drain pan heater. Optional hot gas pan also available.
- Refrigerants R22, R502, R404A, R407A, R407B, R407C, R507.

CONTENTS

	PAGE
Nomenclature.....	Cover
60Hz Capacity & Electrical Data.....	2
50Hz Capacity & Electrical Data.....	3
Wiring Diagram.....	4
Dimensional Data.....	5
Hot Gas Piping.....	6
Nozzle Selections.....	6
Alco TXV Selections.....	7
Sporlan TXV Selections.....	8
Pictorial Views.....	9
Application.....	9
Installation.....	9
Inspection.....	9
Location.....	9
Mounting.....	10
Drain Line.....	10
Piping.....	10
Wiring.....	10
System Check.....	10
Maintenance.....	10
Service Parts List.....	11
Service Log.....	Back

60Hz SPECIFICATIONS

Capacity Data - (BTUH) @ 10°F TD - 60Hz

EVAP TEMP °F	MODEL JUCT										
	116	119	124	230	238	245	251	360	364	375	
+20 / +25	19000	23000	29000	36000	46000	53000	60000	70000	76000	88000	
+10	18620	22540	28420	35280	45080	51940	58800	68600	74480	86240	
0	18050	21850	27550	34200	43700	50350	57000	66500	72200	83600	
-10	17290	20930	26390	32760	41860	48230	54600	63700	69160	80080	
-20	16150	19550	24650	30600	39100	45050	51000	59500	64600	74800	
-30	15010	18170	22910	28440	36340	41870	47400	55300	60040	69520	
-40	13680	16560	20880	25920	33120	38160	43200	50400	54720	63360	
CFM	3100	4700	4550	9400	9400	9200	9100	13650	13650	13650	
REFRIG	LBS	5.8	5.4	8.2	8.5	10.8	12.6	16.1	19.6	22.4	24.5
CHARGE*	KG	2.6	2.5	3.7	3.9	4.9	5.7	7.3	8.9	10.2	11.1

* Charge based at -20°F SST, Coil 30% full, R404A

208-230/1/60

Electrical Data - 60HZ

MODEL	FAN MOTORS				DRAIN PAN HEATER (IF APPLIC)			
	QTY	TOTAL FLA	MCA	MOP	WATTS	AMPS	MCA	MOP
JUCT116	1	3.3	4.13	15	512	2.23	2.78	15
JUCT119	1	3.3	4.13	15	750	3.26	4.08	15
JUCT124	1	3.3	4.13	15	750	3.26	4.08	15
JUCT230	2	6.6	7.43	15	1320	5.74	7.17	15
JUCT238	2	6.6	7.43	15	1320	5.74	7.17	15
JUCT245	2	6.6	7.43	15	1320	5.74	7.17	15
JUCT251	2	6.6	7.43	15	1320	5.74	7.17	15
JUCT360	3	9.9	10.73	15	1890	8.22	10.27	15
JUCT364	3	9.9	10.73	15	1890	8.22	10.27	15
JUCT375	3	9.9	10.73	15	1890	8.22	10.27	15

208-230/3/60

MODEL	FAN MOTORS				DRAIN PAN HEATER (IF APPLIC)			
	QTY	TOTAL FLA	MCA	MOP	WATTS	AMPS	MCA	MOP
JUCT116	1	2.0	2.5	15	512	2.23	2.78	15
JUCT119	1	2.0	2.5	15	750	3.26	4.08	15
JUCT124	1	2.0	2.5	15	750	3.26	4.08	15
JUCT230	2	4.0	4.5	15	1320	5.74	7.17	15
JUCT238	2	4.0	4.5	15	1320	5.74	7.17	15
JUCT245	2	4.0	4.5	15	1320	5.74	7.17	15
JUCT251	2	4.0	4.5	15	1320	5.74	7.17	15
JUCT360	3	6.0	6.5	15	1890	8.22	10.27	15
JUCT364	3	6.0	6.5	15	1890	8.22	10.27	15
JUCT375	3	6.0	6.5	15	1890	8.22	10.27	15

460/3/60

MODEL	FAN MOTORS				DRAIN PAN HEATER (IF APPLIC)			
	QTY	TOTAL FLA	MCA	MOP	WATTS	AMPS	MCA	MOP
JUCT116	1	1.0	1.25	15	512	1.11	1.39	15
JUCT119	1	1.0	1.25	15	750	1.63	2.04	15
JUCT124	1	1.0	1.25	15	750	1.63	2.04	15
JUCT230	2	2.0	2.25	15	1320	2.87	3.59	15
JUCT238	2	2.0	2.25	15	1320	2.87	3.59	15
JUCT245	2	2.0	2.25	15	1320	2.87	3.59	15
JUCT251	2	2.0	2.25	15	1320	2.87	3.59	15
JUCT360	3	3.0	3.25	15	1890	4.11	5.14	15
JUCT364	3	3.0	3.25	15	1890	4.11	5.14	15
JUCT375	3	3.0	3.25	15	1890	4.11	5.14	15

575/3/60

MODEL	FAN MOTORS				DRAIN PAN HEATER (IF APPLIC)			
	QTY	TOTAL FLA	MCA	MOP	WATTS	AMPS	MCA	MOP
JUCT116	1	0.8	1.0	15	512	0.89	1.11	15
JUCT119	1	0.8	1.0	15	750	1.3	1.63	15
JUCT124	1	0.8	1.0	15	750	1.3	1.63	15
JUCT230	2	1.6	1.8	15	1320	2.3	2.87	15
JUCT238	2	1.6	1.8	15	1320	2.3	2.87	15
JUCT245	2	1.6	1.8	15	1320	2.3	2.87	15
JUCT251	2	1.6	1.8	15	1320	2.3	2.87	15
JUCT360	3	2.4	2.6	15	1890	3.29	4.11	15
JUCT364	3	2.4	2.6	15	1890	3.29	4.11	15
JUCT375	3	2.4	2.6	15	1890	3.29	4.11	15

M.C.A. = Minimum Circuit Ampacity

M.O.P. = Maximum Overcurrent Protection

On dual rated voltages the heater wattages and amperages are rated at the higher voltage rating. All fan motors are 3/4 HP

50Hz SPECIFICATIONS

Capacity Data - (BTUH) @ 10°F TD - 50Hz

EVAP TEMP °F	MODEL JUCT										
	116	119	124	230	238	245	251	360	364	375	
+20 / +25	17480	21160	26680	33120	42320	48760	55200	64400	69920	80960	
+10	17130	20737	26146	32458	41474	47785	54096	63112	68522	79341	
0	16606	20102	25346	31464	40204	46322	52440	61180	66424	76912	
-10	15907	19256	24279	30139	38511	44372	50232	58004	63627	73674	
-20	14858	17986	22678	28152	35972	41446	46920	54740	59432	68816	
-30	13809	16716	21077	26165	33433	38520	43608	50876	55237	63958	
-40	12586	15235	19210	23846	30470	35107	39744	46368	50342	58291	
CFM	2570	3900	3780	7800	7800	7650	7550	11330	11330	11330	
REFRIG	LBS	5.8	5.4	8.2	8.5	10.8	12.6	16.1	19.6	22.4	24.5
CHARGE*	KG	2.6	2.5	3.7	3.9	4.9	5.7	7.3	8.9	10.2	11.1

* Charge based at -20°F SST, Coil 30% full, R404A

200-220/1/50

Electrical Data - 50HZ

MODEL	FAN MOTORS				DRAIN PAN HEATER (IF APPLIC)			
	QTY	TOTAL FLA	MCA	MOP	WATTS	AMPS	MCA	MOP
JUCT116	1	3.1	3.88	15	468	2.13	2.66	15
JUCT119	1	3.1	3.88	15	686	3.12	3.9	15
JUCT124	1	3.1	3.88	15	686	3.12	3.9	15
JUCT230	2	6.2	6.98	15	1208	5.49	6.86	15
JUCT238	2	6.2	6.98	15	1208	5.49	6.86	15
JUCT245	2	6.2	6.98	15	1208	5.49	6.86	15
JUCT251	2	6.2	6.98	15	1208	5.49	6.86	15
JUCT360	3	9.3	10.08	15	1729	7.86	9.83	15
JUCT364	3	9.3	10.08	15	1729	7.86	9.83	15
JUCT375	3	9.3	10.08	15	1729	7.86	9.83	15

200-220/3/50

MODEL	FAN MOTORS				DRAIN PAN HEATER (IF APPLIC)			
	QTY	TOTAL FLA	MCA	MOP	WATTS	AMPS	MCA	MOP
JUCT116	1	1.7	2.13	15	468	2.13	2.66	15
JUCT119	1	1.7	2.13	15	686	3.12	3.9	15
JUCT124	1	1.7	2.13	15	686	3.12	3.9	15
JUCT230	2	3.4	3.83	15	1208	5.49	6.86	15
JUCT238	2	3.4	3.83	15	1208	5.49	6.86	15
JUCT245	2	3.4	3.83	15	1208	5.49	6.86	15
JUCT251	2	3.4	3.83	15	1208	5.49	6.86	15
JUCT360	3	5.1	5.53	15	1729	7.86	9.83	15
JUCT364	3	5.1	5.53	15	1729	7.86	9.83	15
JUCT375	3	5.1	5.53	15	1729	7.86	9.83	15

380-400/3/50

MODEL	FAN MOTORS				DRAIN PAN HEATER (IF APPLIC)			
	QTY	TOTAL FLA	MCA	MOP	WATTS	AMPS	MCA	MOP
JUCT116	1	0.8	1.0	15	567	1.42	1.77	15
JUCT119	1	0.8	1.0	15	831	2.08	2.6	15
JUCT124	1	0.8	1.0	15	831	2.08	2.6	15
JUCT230	2	1.6	1.8	15	1463	3.66	4.57	15
JUCT238	2	1.6	1.8	15	1463	3.66	4.57	15
JUCT245	2	1.6	1.8	15	1463	3.66	4.57	15
JUCT251	2	1.6	1.8	15	1463	3.66	4.57	15
JUCT360	3	2.4	2.6	15	2094	5.24	6.54	15
JUCT364	3	2.4	2.6	15	2094	5.24	6.54	15
JUCT375	3	2.4	2.6	15	2094	5.24	6.54	15

M.C.A. = Minimum Circuit Ampacity

M.O.P. = Maximum Overcurrent Protection

On dual rated voltages the heater wattages and amperages are rated at the higher voltage rating. All fan motors are 3/4 HP

WIRING DIAGRAM

UNIT COOLER WIRING DIAGRAM – HOT GAS DEFROST

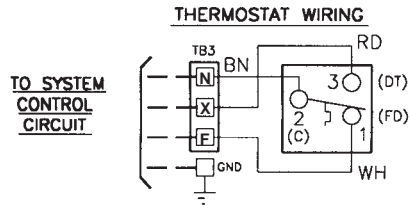

DEFROST CONTROL THERMOSTAT
 MAX. 20.0 AMP.
 FLA 240 A.C.
 FAN DELAY 2(C) & 1(FD)
 CLOSES AT 20°F ±3 (FIXED)
 DEFROST TERMINATION 2(C) & 3(DT)
 CLOSES AT 40 TO 75°F ±5 (ADJUSTABLE)

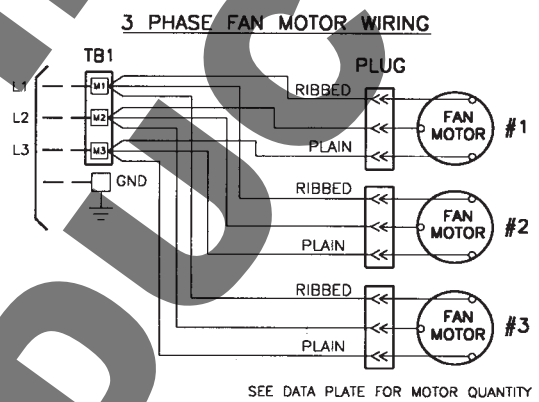
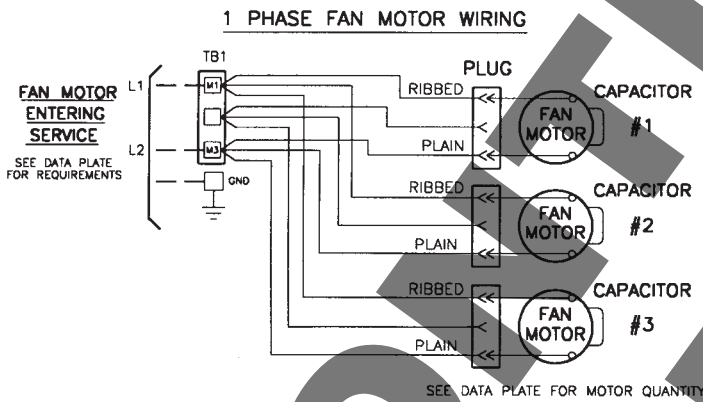
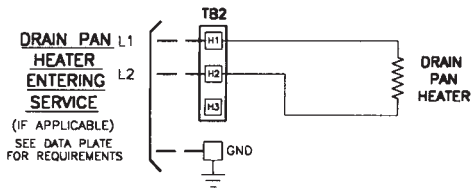

ELECTRICAL COMPONENT LAYOUT 3 PHASE SHOWN

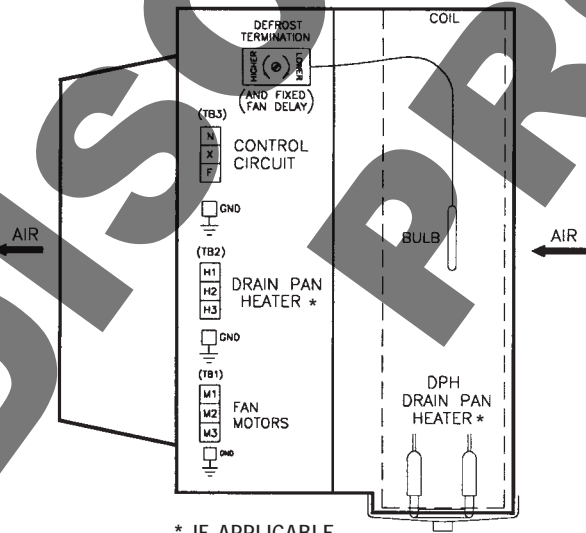

NOTES

- FACTORY WIRING
- - - - - WIRING BY OTHERS
- ** ALL FIELD WIRING TO BE IN COMPLIANCE WITH ALL APPLICABLE LOCAL AND NATIONAL CODES.
- ON 3 FAN MODELS, SUCTION HEADER IS AT ELECTRICAL END OF UNIT

DIMENSIONAL DATA

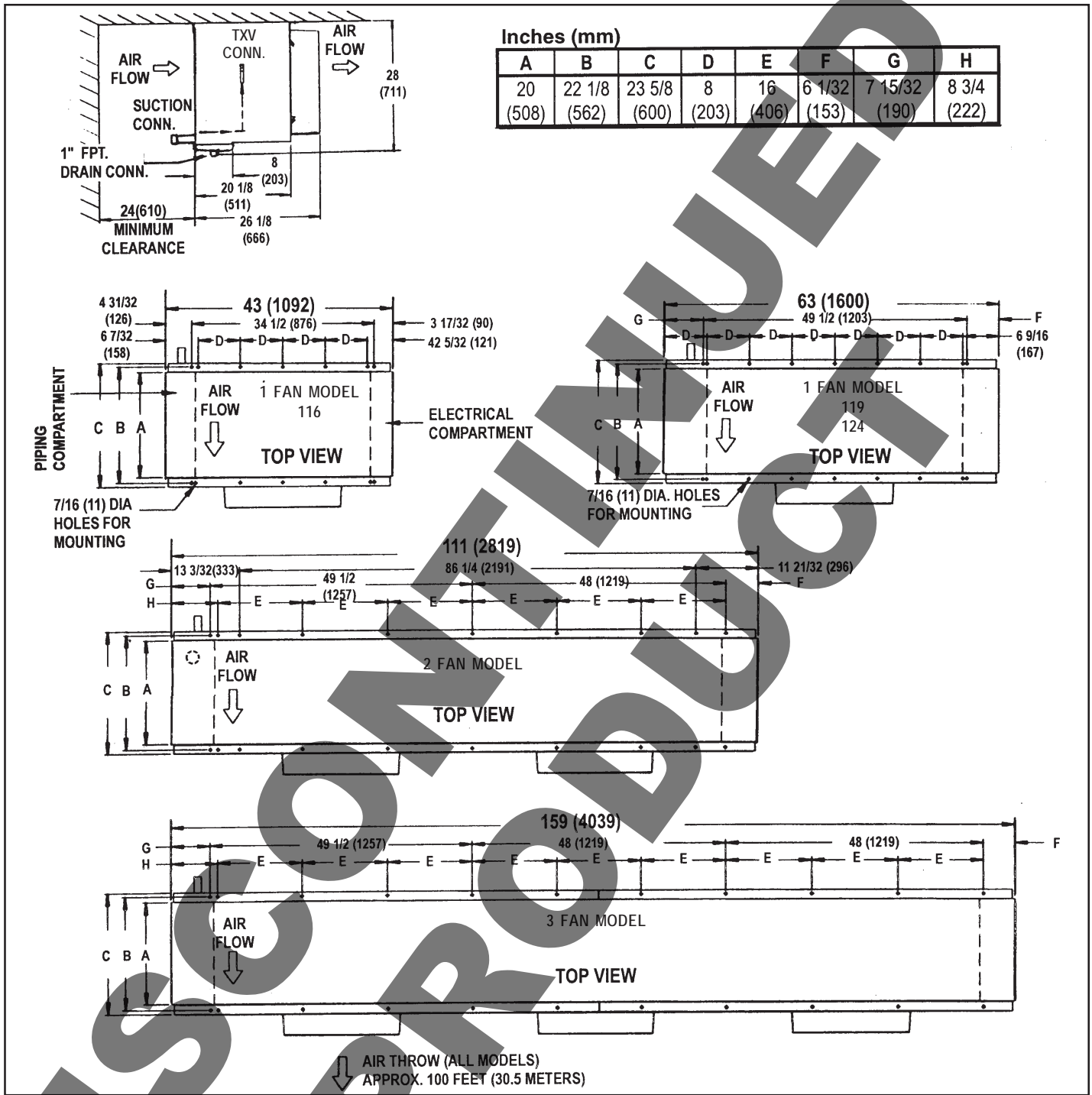

DIMENSIONAL DATA (INCHES)

Hot Gas Defrost Model		116	119	124	230	238	245	251	360	364	375
Number of Fans		1	1	1	2	2	2	2	3	3	3
TXV Connection (inlet to distributor) (O.D. Sweat)		1/2	5/8	5/8	7/8	7/8	7/8	7/8	7/8	7/8	7/8
Suction Connection (O.D. Sweat)		7/8	1 1/8	1 3/8	1 3/8	1 5/8	1 5/8	1 5/8	1 5/8	2 1/8	2 1/8
Hot Gas Side Port Distributor Connection (O.D. Sweat)		5/8	5/8	7/8	7/8	7/8	7/8	1 1/8	1 1/8	1 1/8	1 1/8
Hot Gas Drain Connection (O.D. Sweat)		7/8 Inlet & Outlet			1-1/8 Inlet & Outlet			1-3/8 Inlet - 1-1/8 Outlet			
Approx. Shipping Weight	Lbs.	160	190	205	350	370	380	390	540	560	580
	Kg	73	86	93	159	168	173	177	245	227	264

HOT GAS PIPING

MODELS WITH ELECTRIC DRAIN PAN HEATER

3 PIPE DEFOST WITH ELECTRIC DRAIN PAN HEATER

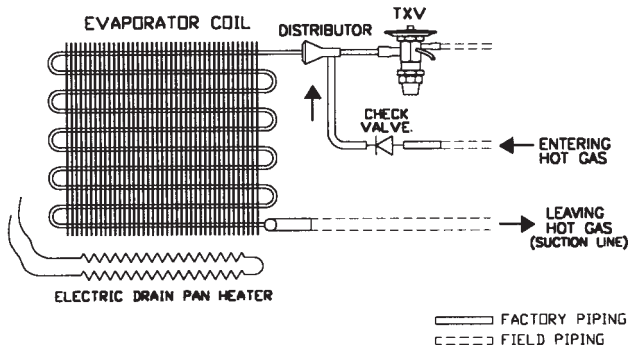

REVERSE CYCLE DEFOST WITH ELECTRIC DRAIN PAN HEATER

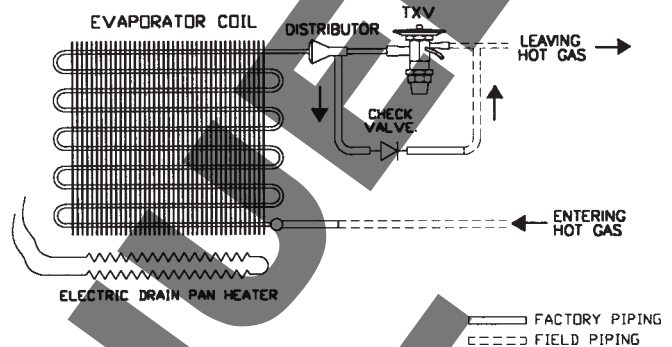

MODELS WITH HOT GAS DRAIN PAN HEATER

3 PIPE DEFOST WITH HOT GAS DRAIN PAN LOOP

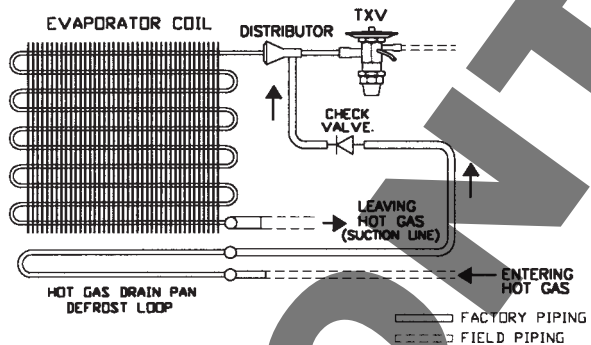

REVERSE CYCLE DEFOST WITH HOT GAS DRAIN PAN LOOP

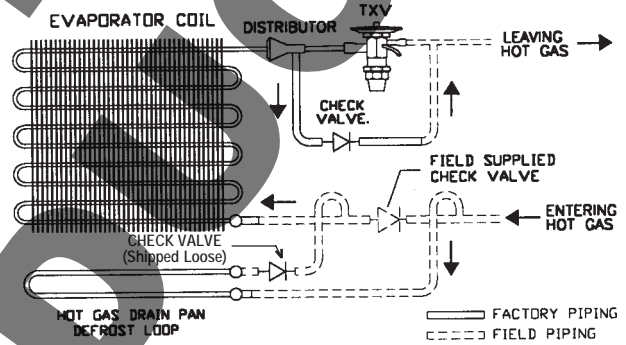

DISTRIBUTOR NOZZLE SELECTION

* STANDARD NOZZLES SUPPLIED LOOSE BY THE FACTORY FOR STOCK MODELS LESS TXV

T.D.	8°F to 12°F	
** TEMP. RANGE	25°F to - 40°F	25°F to - 40°F
REFRIGERANT		
MODEL NO.	R-502, R-404A, R-507	R-22
JUCT116	G-3	G-2
JUCT119	E-4	E-2 1/2
JUCT124	E-5	E-3
JUCT230	E-6	E-4
JUCT238	C-8	C-5
JUCT245	C-10	C-6
JUCT251	A-12	A-6
JUCT360	A-12	A-8
JUCT364	A-15	A-10
JUCT375	A-17	A-12

* Nozzles, for various refrigerant types are included in a bag. Factory built-to-order units have nozzle factory installed.

** Evaporator temperature

If correct nozzle is not available, the proper orifice size can be drilled in the field using the following chart:

NOZZLE ORIFICE NO.	DRILL SIZE (IN)
1-1/2	0.120
2	0.141
2-1/2	0.157
3	0.172
4	0.199
5	0.211
6	0.242
8	0.266
10	0.281
12	0.312
15	0.348
17	0.368
20	0.404

ALCO TXV SELECTIONS

R404A - R507		MODEL JUCT									
EVAP TEMP	116		119		124		230		238		
	BTUH	VALVE #	BTUH	VALVE#	BTUH	VALVE #	BTUH	VALVE #	BTUH	VALVE #	
+20/+25°F	19000	HFES	23000	HFES	29000	HFES	36000	HFES	46000	HFES	
+10°F	18620	1 1/2-RC	22540	1 1/2-RC	28420	2-RC	35280	3 1/2-RC	45080	3 1/2-RC	
0°F	18050		21850		27550		34200		43700		
-10°F	17290	HFES	20930	HFES	26390	HFES	32760	HFES	41860	HFES	
-20°F	16150	1 1/2-RZ	19550	2-RZ	24650	3 1/2-RZ	30600	3 1/2-RZ	39100	5-RZ	
-30°F	15010		18170		22910		28440		36340		
-40°F	13680	HFES 2-RZ	16560		20880		25920		33120		
EVAP TEMP	245		251		360		364		375		
	BTUH	VALVE #	BTUH	VALVE #	BTUH	VALVE #	BTUH	VALVE #	BTUH	VALVE #	
+20/+25°F	53000	HFES	60000	HFES	70000	HFES	76000	HFES	88000	HFES	
+10°F	51940	3 1/2-RC	58800	3 1/2-RC	68600	5-RC	74480	5-RC	86240	7-RC	
0°F	50350		57000		66500		72200		83600		
-10°F	48230	HFES	54600	HFES	63700	HFES	69160	HFES	80080	HFES	
-20°F	45050	5-RZ	51000	5-RZ	59500	7-RZ	64600	7-RZ	74800	10-RZ	
-30°F	41870		47400		55300		60040	HFES 10-RZ	69520		
-40°F	38160	HFES 7-RZ	43200	HFES 7-RZ	50400	HFES 10-RZ	54720		63360		

R22		MODEL JUCT									
EVAP TEMP	116		119		124		230		238		
	BTUH	VALVE #	BTUH	VALVE#	BTUH	VALVE #	BTUH	VALVE #	BTUH	VALVE #	
+20/+25°F	19000	HFES	23000	HFES	29000	HFES	36000	HFES	46000	HFES	
+10°F	18620	1 1/2-HC	22540	1 1/2-HC	28420	2-HC	35280	2 1/2-HC	45080	3-HC	
0°F	18050		21850		27550		34200		43700		
-10°F	17290	HFES	20930	HFES	26390	HFES	32760	HFES	41860	HFES	
-20°F	16150	2-HZ	19550	2 1/2-HZ	24650	2 1/2-HZ	30600	3-HZ	39100	5 1/2-HZ	
-30°F	15010	HFES	18170		22910	HFES	28440	HFES	36340		
-40°F	13680	2 1/2-HZ	16560		20880	3-HZ	25920	5 1/2-HZ	33120		
EVAP TEMP	245		251		360		364		375		
	BTUH	VALVE #	BTUH	VALVE #	BTUH	VALVE #	BTUH	VALVE #	BTUH	VALVE #	
+20/+25°F	53000	HFES	60000	HFES	70000	HFES	76000	HFES	88000	HFES	
+10°F	51940	3-HC	58800	5 1/2-HC	68600	5 1/2-HC	74480	5 1/2-HC	86240	5 1/2-HC	
0°F	50350		57000		66500		72200		83600		
-10°F	48230	HFES	54600	HFES	63700	HFES	69160	HFES	80080	HFES	
-20°F	45050	5 1/2-HZ	51000	5 1/2-HZ	59500	8-HZ	64600	8-HZ	74800	8-HZ	
-30°F	41870		47400		55300		60040		69520		
-40°F	38160		43200	HFES 8-HZ	50400		54720	HFES 10-HZ	63360	HFES 10-HZ	

Where available use the HFESC series valve which includes sweat fittings with a removable/cleanable inlet screen.

Note: Above Selections are based on 100 °F Entering Liquid Temperature.

** Factory built to order models will include Nozzle factory mounted.

All stocking ordered models will include Nozzles in a bag attached to distributor. (to be selected and installed by contractor)

SPORLAN TXV SELECTIONS

R502* - 404A - R507		MODEL JUXT									
EVAP TEMP	116		119		124		230		238		
	BTUH	VALVE #	BTUH	VALVE #	BTUH	VALVE #	BTUH	VALVE #	BTUH	VALVE #	
+20/25 °F	19000	EGSE 1 1/2-C	23000	EGSE	29000	EGSE 2-C	36000	SSE 3-C	46000	SSE 4-C	
+10 °F	18620		22540	1 1/2-C	28420		35280		45080		
0 °F	18050		21850	EGSE 2-C	27550		34200		43700		
-10 °F	17290	EGSE 1 1/2-ZP	20930	EGSE 2-ZP	26390	EGSE 2-ZP	32760	SSE 3-ZP	41860	SSE 4-ZP	
-20 °F	16150		19550		24650	30600	39100				
-30 °F	15010		18170		22910	28440	36340				
-40 °F	13680		16560		20880	25920	33120				
-40 °F	13680		16560		20880	25920	33120				
EVAP TEMP	245		251		360		364		375		
EVAP TEMP	BTUH	VALVE #	BTUH	VALVE #	BTUH	VALVE #	BTUH	VALVE #	BTUH	VALVE #	
+20/25 °F	53000	SSE 4-C	60000	SSE 4-C	70000	SSE 6-C	76000	SSE-6-C	88000	SSE 7-C	
+10 °F	51940		58800	SSE 4-C	68600	SSE 6-C	74480	SSE 7-C	86240	EBSSE 7 1/2-C	
0 °F	50350		57000	SSE 6-C	66500	SSE 7-C	72200		83600		
-10 °F	48230	SSE 4-ZP	54600	SSE 6-ZP	63700	SSE 6-ZP	69160	SSE 7-ZP	80080	SSE 7-ZP	
-20 °F	45050	SSE 6-ZP	51000		59500	64600	74800				
-30 °F	41870		47400		55300	60040	69520		OSE 9-ZP		
-40 °F	38160		43200		SSE 7-ZP	50400	54720			63360	
-40 °F	38160		43200		SSE 7-ZP	50400	54720		63360	63360	

R22		MODEL JUXT									
EVAP TEMP	116		119		124		230		238		
	BTUH	VALVE #	BTUH	VALVE #	BTUH	VALVE #	BTUH	VALVE #	BTUH	VALVE #	
+20/25 °F	19000	EGVE 1 1/2-C	23000	EGVE	29000	EGVE 2-C	36000	EGVE 3-C	46000	EGVE 3-C	
+10 °F	18620		22540	1 1/2-C	28420		35280		45080		
0 °F	18050		21850	EGVE 2-C	27550		34200		43700		
-10 °F	17290	EGVE 2-ZP40	20930	EGVE 2-ZP40	26390	EGVE 3-ZP40	32760	SVE 4-ZP40	41860	SVE 4-ZP40	
-20 °F	16150		19550		24650		30600		39100		
-30 °F	15010		18170		22910		28440		36340		
-40 °F	13680		16560		20880		25920		33120		
-40 °F	13680		16560		20880		25920		33120		
EVAP TEMP	245		251		360		364		375		
EVAP TEMP	BTUH	VALVE #	BTUH	VALVE #	BTUH	VALVE #	BTUH	VALVE #	BTUH	VALVE #	
+20/25 °F	53000	SVE 4-C	60000	SVE 4-C	70000	SVE 5-C	76000	SVE 5-C	88000	SVE 8-C	
+10 °F	51940		58800	SVE 4-C	68600		SVE 5-C	74480	86240		
0 °F	50350		57000	SVE 6-C	66500		SVE 7-C	72200	83600		
-10 °F	48230	SVE 5-ZP40	54600	SVE 5-ZP40	63700	SVE 8-ZP40	69160	SVE 8-ZP40	80080	SVE 10-ZP40	
-20 °F	45050		51000	SVE 8-ZP40	59500		64600		74800		
-30 °F	41870		47400		55300		60040		69520		
-40 °F	38160		43200		SVE 10-ZP40		50400		54720		63360
-40 °F	38160		43200		SVE 10-ZP40		50400		54720		63360

* Valve part numbers are coded for R404A (also may be used on R502 or R507)

Note: Above Selections are based on 100 °F Entering Liquid Temperature.

** Factory built to order models will include Nozzle factory mounted.

All stocking ordered models will include Nozzles in a bag attached to distributor. (to be selected and installed by contractor)

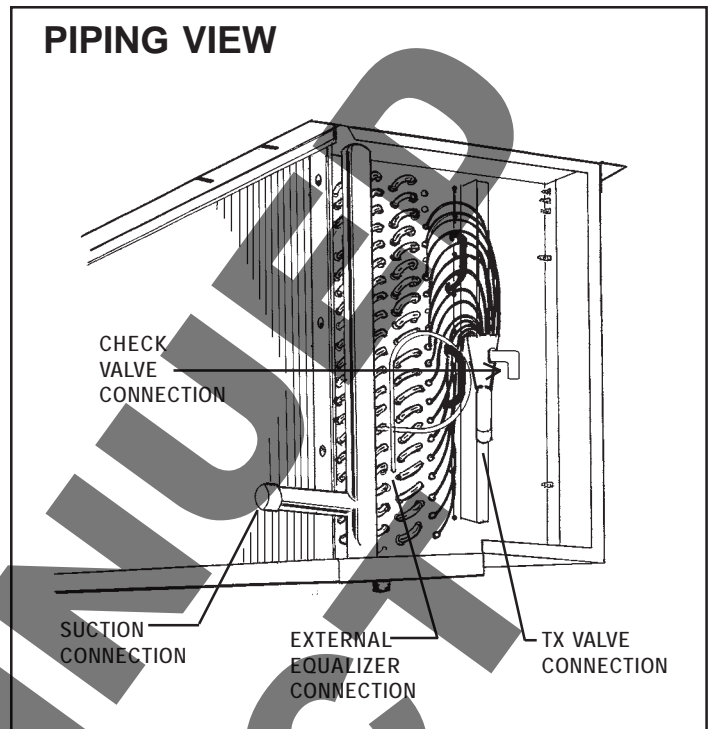
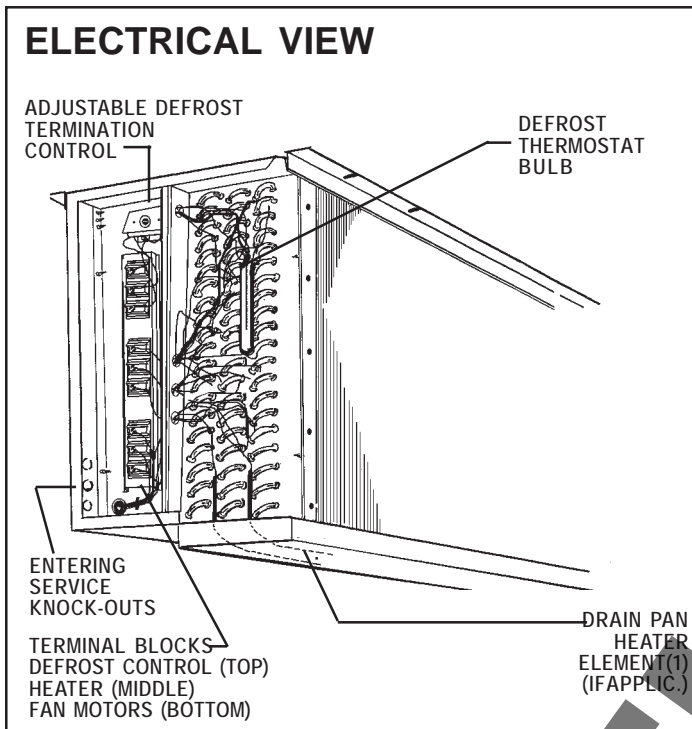

APPLICATION

Unit Coolers are designed for use with R22, R404A, R407A/B/C, R507 or R502 refrigerants. At room temperatures above 34°F and evaporating temps no lower than 27°F the air flowing through the coil will accomplish the defrost. Temperatures of 34°F and below (to -40°F) require positive defrosting (either Electric or Hot Gas). These models require the use of (1) Time Clock (to initiate and terminate the defrost cycle). (2) Fan-Delay thermostat (to prevent evaporator fans from starting up right after defrost and blowing water on to fan blades, guards and floor) (3) Defrost Termination Control (to prevent unnecessary prolonged heating and steaming of the coil once all the ice and frost has melted).

The coil must not be exposed to any abnormal atmospheric or acidic environments. This may result in corrosion to the cabinet and possible coil failure (leaks). (Consult manufacturer for optional baked on phenolic protective coatings).

INSTALLATION

The installation and start-up of the Unit Coolers should only be performed by qualified refrigeration mechanics. This equipment should be installed in accordance with all applicable codes, ordinances and local by-laws.

INSPECTION

Inspect all equipment before unpacking for visible signs of damage or loss. Check shipping list against material received to ensure shipment is complete.

IMPORTANT: Remember, you, the consignee, must make any claim necessary against the transportation company. Shipping damage or missing parts, when discovered at the outset, will prevent later unnecessary and costly delays. **If damage or loss during transport is evident, make claim to carrier, as this will be their responsibility, not the manufacturer's.**

Should carton be damaged, but damage to equipment is not obvious, a claim should be filed for "concealed damage" with the carrier.

IMPORTANT: The electrical characteristics of the unit should be checked at this time to make sure they correspond to those ordered and to electrical power available at the job site. Save all shipping papers, tags and instruction sheets for reference by installer and owner.

LOCATION

The unit location in the room should be selected to ensure uniform air distribution throughout the entire space to be refrigerated. Be sure that the unit does not draw air in, or blow directly out, through an opened door and that the product does not obstruct the free circulation of air. Allow a minimum of 24" clearance at each end and behind the unit.

The Unit Coolers draw air through the coil and discharge air from the fan side.

Consideration should be given to the coil location in order to minimize the piping run length to the condensing unit and floor drain.

MOUNTING

Mounting brackets with 7/16" dia holes are provided for flush mounting to the ceiling. For details refer to dimensional data on page 5. Ensure adequate clearance (at least 24") is provided behind the coil as well as each side (to enable access to the electrical and refrigerant compartments).

Ensure that the ceiling is level since the drain pan has been sloped for drainage during the defrost cycle.

DRAIN LINE

The drain line should be run from the drain connection, sloping at least 4" per foot. A trap outside the room will prevent warm air from entering through the tubing. Connection should be made to proper drainage facilities that comply with local regulations.

To prevent freeze-up when the temperature of the refrigerated space is 32 °F or lower, the drain line should be heated along its run inside the cold room. The heated drain line should be insulated. It is recommended that the heater be energized at all times. A heat input of 20 watts per foot in a 0 °F room and 30 watts per foot in a -20 °F room is usually satisfactory.

The drain pan may be mounted with the drain fitting at either end (remove pan heater and relocate pan). See page 5 for drain fitting details.

Ensure that the drain pan has sufficient slope for proper drainage (prevention of ice build up/blockage in pan).

PIPING

Refrigerant line sizes are important and may not be the same size as the coil connections. (depends on the length of run) If in doubt, consult "Recommended refrigerant line sizes" charts. (Engineering Manuals or other recognized sources of information).

WIRING

Wire system in accordance with governing standards and local codes. See data and wiring diagrams on pages 2, 3 and 4 for wiring arrangement. Electrical wiring is to be sized in accordance with minimum circuit ampacity rating.

For ease of identifying the proper wiring terminals, unit wiring is colour coded and terminal block connections are identified. When **fan delay thermostats** (combination fan delay and defrost termination) are installed, on start-up, the fans do not operate until the coil temperature is reduced to approximately 20 °F. It is normal for the fans to cycle a few times until the room temperature is brought down. At higher evaporating temperatures this control may not close and therefore should be by-passed or replaced with an adjustable type.

The **defrost termination control** is adjustable and may be set at a minimum of 40 °F (fully CW) to a maximum of 75 °F (fully CCW). Normal setting is 55 °F. This can be increased if the hot gas cycle is terminated too soon (frost still left) or decreased if terminated too long (steaming of coil). Time clock should be set for a fail-safe time termination of 20 minutes.

SYSTEM CHECK

Before Start-Up:

1. All wiring should be in accordance with local codes.
2. Refrigerant lines should be properly sized.
3. All systems should include a liquid line solenoid valve.
4. Thorough evacuation and dehydration has been performed.
5. The suction, discharge, and receiver service valves must be open.
6. The system should include a liquid line drier moisture indicator and suction filter.
7. Pour enough water into the drain pan to allow a good check on drainage and seal the trap.

After Start-Up:

1. If necessary, temporarily by-pass fan delay control to run fans until room temp is lowered. (Run jumper wire from terminal N to F on control circuit terminal block).
2. Check the compressor oil level to ensure the correct oil charge.
3. Be sure that the expansion valve is properly set to provide the correct amount of superheat. (should be around 5 to 6 °F for 10 °F T.D. operation).
4. Heavy moisture loads are usually encountered when starting the system for the first time. If the coil temperature is below freezing, this will cause a rapid build-up of frost on the coil. During the initial pull-down frost build-up should be watched and the coil defrosted manually, as required.
5. Check for proper evaporator fan blade rotation on three phase models.

MAINTENANCE

The unit should be periodically inspected for any dirt or build-up on the fin surface and cleaned if necessary with a soft whisk or brush.

Also ensure coil and pan does not have any excessive ice build-up from improper defrost operation.

SERVICE PARTS LIST

FAN MOTORS - 60Hz		MODELS	PART #			
208-230/1/60	3.3 A 3/4 HP	ALL	1045032			
208-230/3/60	2.0 A 3/4 HP	ALL	1045033			
460/3/60	1.0 A 3/4 HP	ALL	1045034			
575/3/60	0.8 A 3/4 HP	ALL	1045035			
FAN MOTORS - 50Hz		MODELS	PART #			
200-220/1/50	3.1 A 3/4 HP	ALL	1045032			
200-220/3/50	1.7 A 3/4 HP	ALL	1045033			
380-400/3/50	0.8 A 3/4 HP	ALL	1045034			
FAN BLADES		MODELS	PART #			
20" 18° Pitch 4-Blade		116	1048568			
20" 23° Pitch 4-Blade		ALL (EXCEPT 116)	1045115			
FAN GUARDS		MODELS	PART #			
Moulded Throw Booster (standard)		ALL	1045089			
Metal Wire (optional)		ALL	1045091			
Acorn Nut		ALL	1045138			
Motor Mount		MODELS	PART #			
		ALL	1045031			
Terminal Block - Fan Motor		MODELS	PART #			
Terminal Block- Drain Pan Heater (if applic.)		ALL	1045017			
Terminal Block- Control		ALL	1045017			
Defrost Control Thermostat		ALL	1048610			
DRAIN PAN HEATER (IF APPLICABLE)						
MODEL	WATTS	DRAIN PAN HEATER (1 REQUIRED) PART #				
		230V	380V	460V	575V	
116	512	1067848-001	1067848-002	1067848-003	1067848-004	
119,124	750	1067848-005	1067848-006	1067848-007	1067848-008	
230,238,245,251	1320	1067848-009	1067848-010	1067848-011	1067848-012	
360,364,375	1890	1067848-013	1067848-014	1067848-015	1067848-016	

Service Parts List

Label

To Be Attached

HERE

SERVICE LOG

DATE	COMMENTS



NATIONAL REFRIGERATION & AIR CONDITIONING CANADA CORP.
159 Roy Blvd., Brantford, Ontario, Canada N3R 7K1
Phone (519) 751-0444 • Fax (519) 753-1140



Due to National Refrigeration's policy of continuous product improvement, we reserve the right to make changes without notice.

ANSI/NSF 7
1R71